

REVISED 7/1/20

PRODUCT

JUNIP PENDANT
JUNIP 04-004

MATERIALS (FINISHES)

ANODIZED ALUMINUM (AGED
BRONZE, GOLDEN BRASS, SATIN
BLACK, SATIN SILVER)

GLASS (CLEAR, FROSTED, SMOKE)

WEIGHT

5.6 LBS

LAMPING

INTEGRATED LED (QTY 4)
13W, 3000K
DIMMABLE

CANOPY / CORD

ROUND CANOPY
9' BLACK CORD (CLOTH COVERED)

CERTIFICATIONS

ETL LISTED (120V, US/CANADA)

NOTES

JUNIP IS COMPRISED OF MODULAR
COMPONENTS AND IS MEANT TO
BE ASSEMBLED ON-SITE BY A
QUALIFIED AND LICENSED
ELECTRICIAN AND INSTALLATION
PROFESSIONAL.

PATENT PENDING



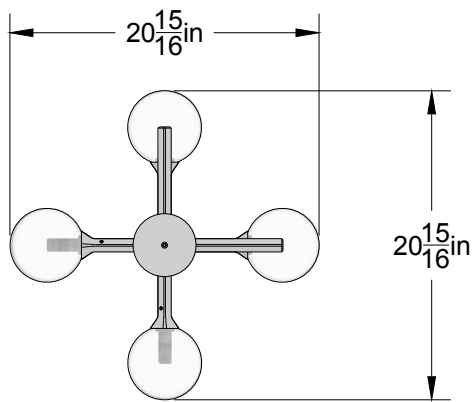

PLAN VIEW

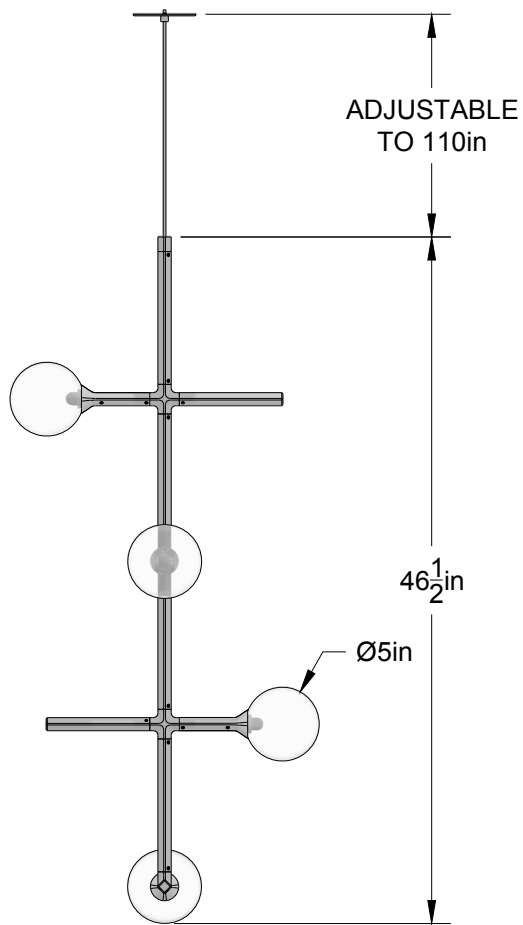

ELEVATION VIEW

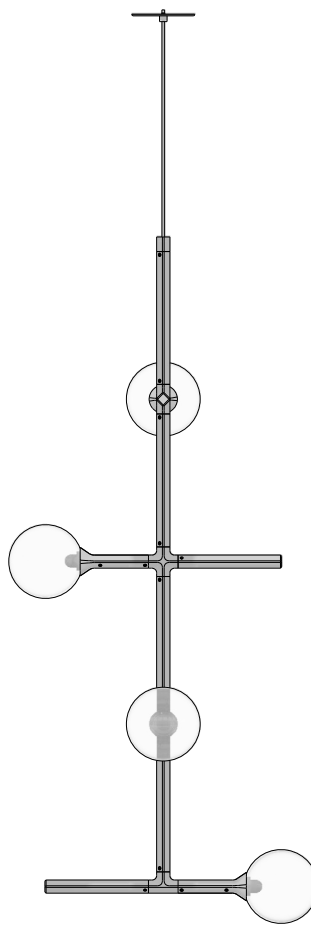

SIDE VIEW

© 2020, LAKE AND WELLS, LLC ALL RIGHTS RESERVED