

REVISED 7/1/20

**PRODUCT**

JUNIP PENDANT  
JUNIP 04-003

**MATERIALS (FINISHES)**

ANODIZED ALUMINUM (AGED  
BRONZE, GOLDEN BRASS, SATIN  
BLACK, SATIN SILVER)

GLASS (CLEAR, FROSTED, SMOKE)

**WEIGHT**

3.6 LBS

**LAMPING**

INTEGRATED LED (QTY 4)  
13W, 3000K  
DIMMABLE

**CANOPY / CORD**

ROUND CANOPY  
9' BLACK CORD (CLOTH COVERED)

**CERTIFICATIONS**

ETL LISTED (120V, US/CANADA)

**NOTES**

JUNIP IS COMPRISED OF MODULAR  
COMPONENTS AND IS MEANT TO  
BE ASSEMBLED ON-SITE BY A  
QUALIFIED AND LICENSED  
ELECTRICIAN AND INSTALLATION  
PROFESSIONAL.

PATENT PENDING



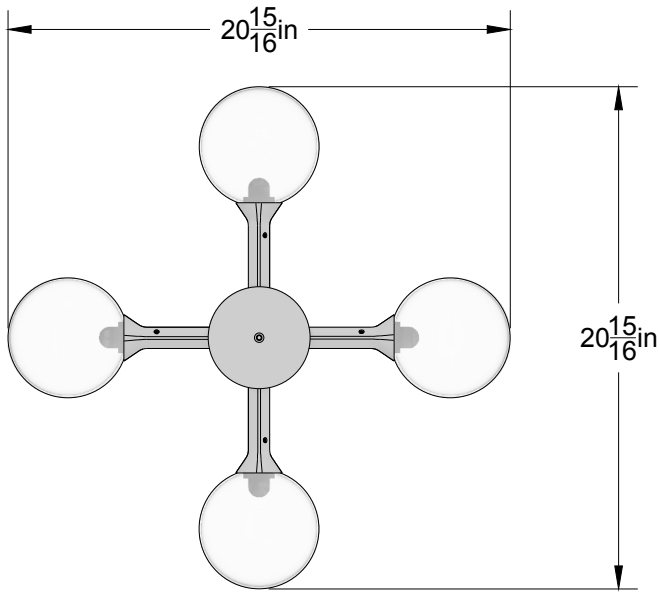

PLAN VIEW

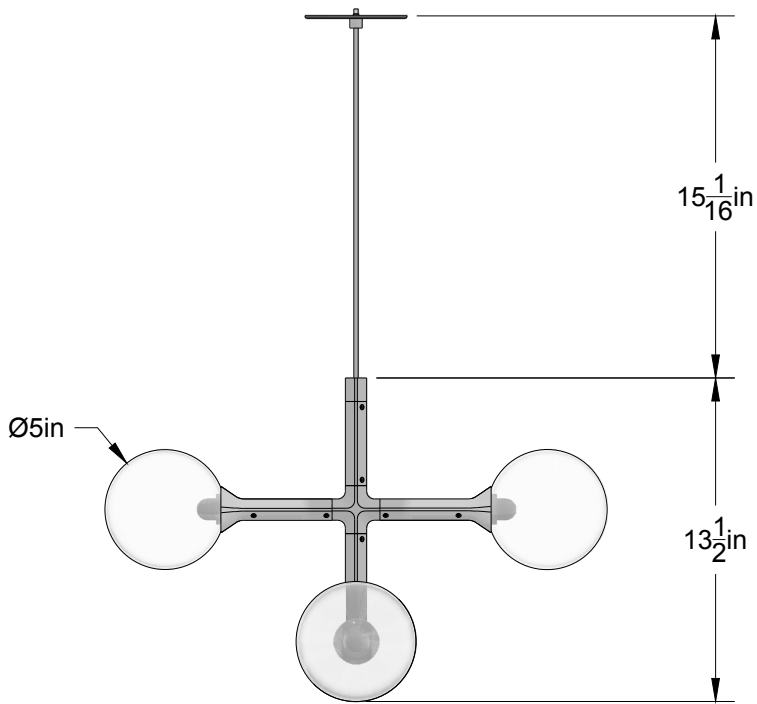

ELEVATION VIEW

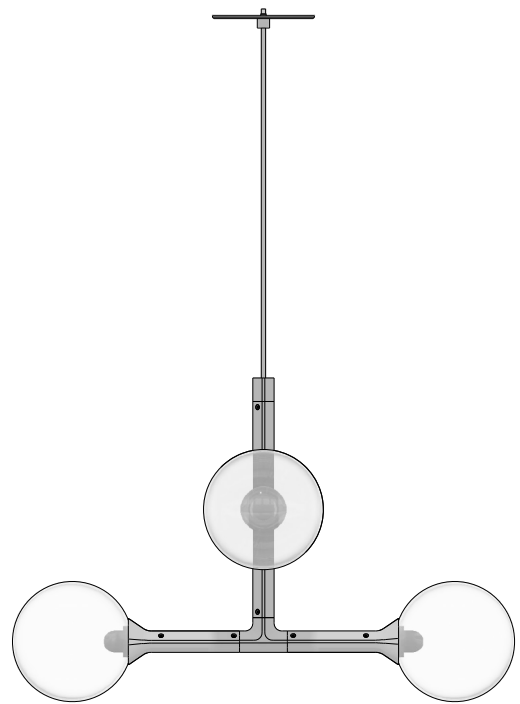

SIDE VIEW

© 2020, LAKE AND WELLS, LLC ALL RIGHTS RESERVED