

REVISED 1/1/19

PRODUCT

RIVELI SHELF - LUXE SERIES
RIVELI 4X3-LUXE-001

MATERIALS (FINISHES)

ANODIZED ALUMINUM (AGED
BRONZE, GOLDEN BRASS, SATIN
BLACK, SATIN SILVER)

WEIGHT

42 LBS
(EACH SHELF CAN HOLD 8 LBS)

NOTES

RIVELI SHELF IS A MODULAR
SYSTEM COMPRISED OF
INDIVIDUAL PIVOTING SHELVES.
RIVELI IS MEANT TO BE
ASSEMBLED ON SITE AND
INSTALLED SECURELY TO A
SUPPORTED WALL BY A LICENSED
INSTALLATION PROFESSIONAL.

PATENT PROTECTED - U.S. PATENT NO. 8,665,583

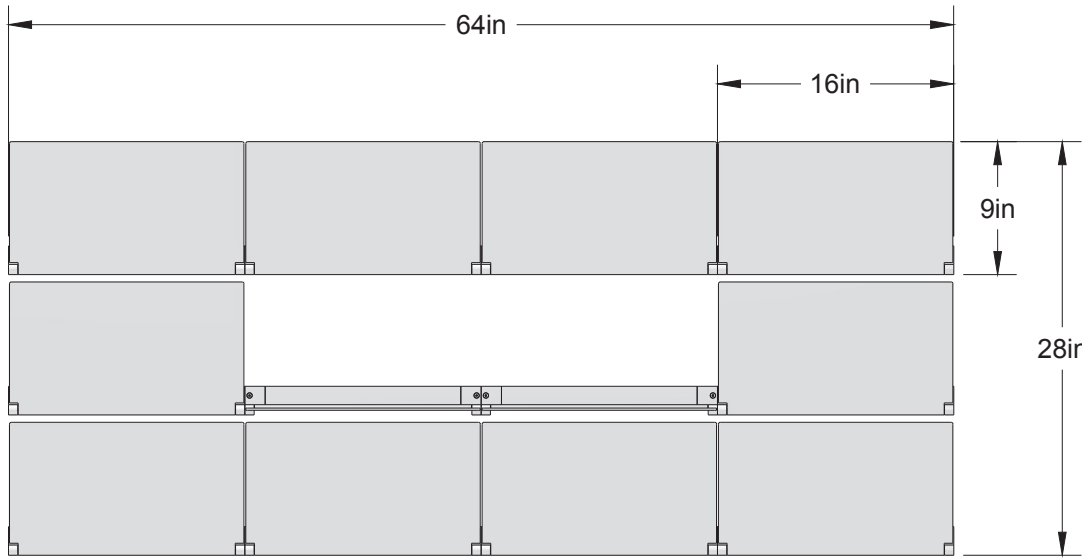

ELEVATION VIEW

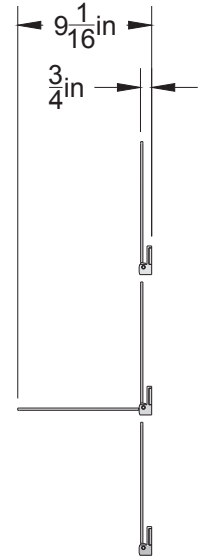

SIDE VIEW

© 2019, LAKE AND WELLS, LLC ALL RIGHTS RESERVED