

REVISED 6/1/19

PRODUCT

JAX CHANDELIER
JAX 09-005

MATERIALS (FINISHES)

ANODIZED ALUMINUM (AGED
BRONZE, GOLDEN BRASS, SATIN
BLACK, SATIN SILVER)

SOLID OPTIC CRYSTAL (CLEAR,
FROSTED, SMOKE)

WEIGHT

5.6 LBS

LAMPING

INTEGRATED LED (QTY 9)
1.3W, 3000K
ELV AND PHASE DIMMABLE

CERTIFICATIONS

ETL LISTED (120V)

NOTES

JAX IS COMPRISED OF MODULAR
COMPONENTS AND IS MEANT TO
BE ASSEMBLED ON-SITE BY A
QUALIFIED ELECTRICIAN AND
INSTALLATION PROFESSIONAL.

PATENT PENDING



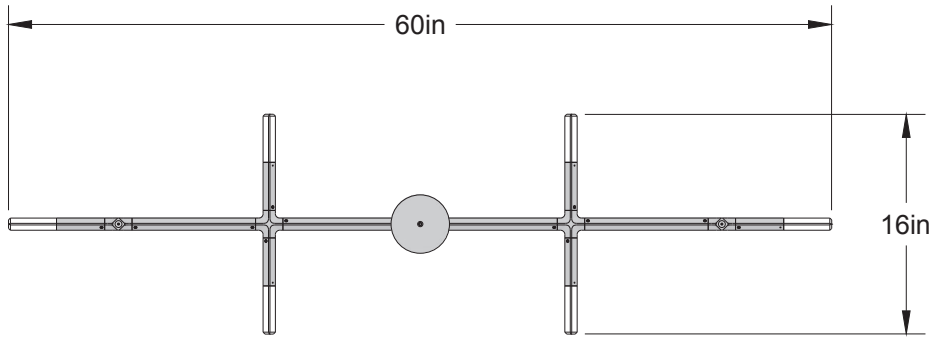

PLAN VIEW

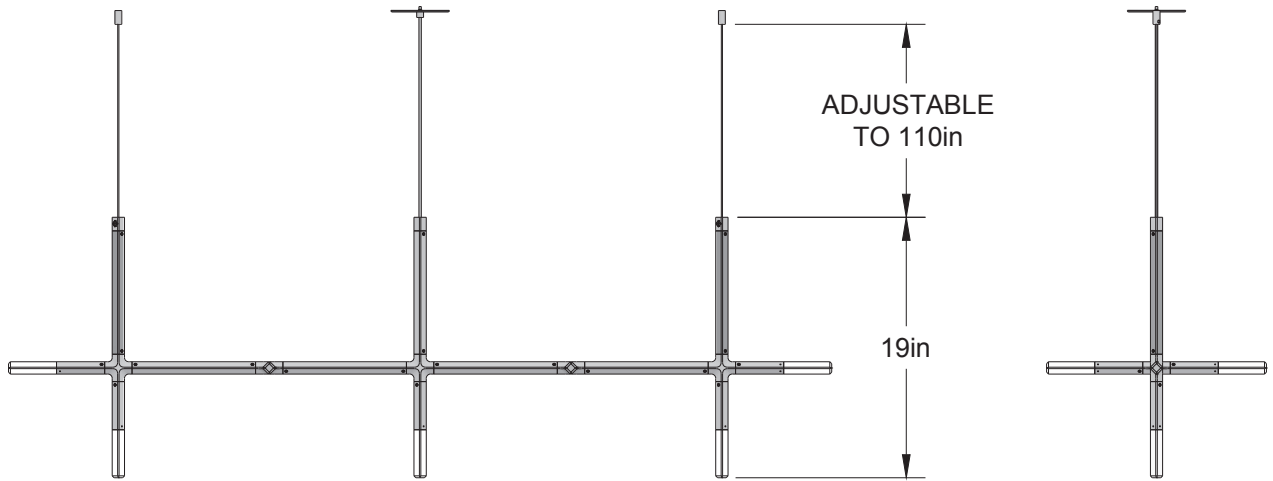

ELEVATION VIEW

SIDE VIEW

© 2019, LAKE AND WELLS, LLC ALL RIGHTS RESERVED